

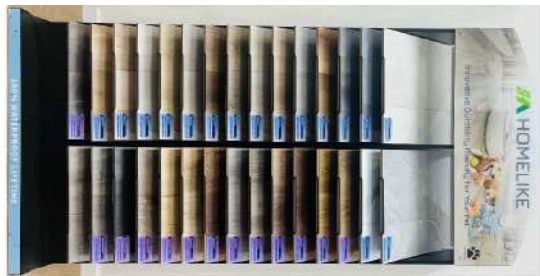

MADE IN USA

Overnight Delivery
Factory Owned Brand
Free Displays/Samples
550,000sf Self-Owned Warehouse in Georgia



HOMELIKE
www.homelikeflooring.com



CONTENT

▶ HOMELIKE BRAND

(GD) - GLUE DOWN LUXURY VINYL 2MM 12MIL	03
 (SU) – SELECT USA RIGID CORE 5.5MM 20MIL	05
(PR) – RIGID CORE PRO WOOD 5.5MM 20MIL	07
(PR) – RIGID CORE PRO STONE 5.5MM 20MIL	09
(PM) – RIGID CORE PRO MAX 6.5MM 20MIL	11
(PA) – PREMIUM RIGID CORE 8MM 28MIL SHIELD4MAX™	13
(PU) – PREMIUM WPC ENGINEERED VINYL 8MM 20MIL	15
(PL) – PREMIUM WATER-RESISTANT LAMINATE 12MM AC3	17

▶ GENERIC COLLECTIONS

(CC) – RIGID CORE LUXURY VINYL 5.0MM 12MIL	19
 (AR) – RIGID CORE LUXURY VINYL 5.0MM 20MIL	21
 (AA) – RIGID CORE LUXURY VINYL 6.5MM 22MIL	25
(WG) – WPC ENGINEERED VINYL 8.0MM 20MIL	27
ACCESSORIES – TRANSITIONS	29
COMPANY INTRODUCTION	34



Identification	Glue Down Luxury Vinyl	Rigid Core Made In USA	Rigid Core Pro	Rigid Core Pro Max	Rigid Core Signature	WPC Engineered Vinyl	Water Resistant Laminate
Installation	Glue Down	UNICLIC	UNICLIC	UNICLIC	UNICLIC	UNICLIC	UNICLIC
Waterproof?	✓	✓	✓	✓	✓	✓	○
ScratchGuard Finish?	✓	✓	✓	✓	SHIELD4MAX™	✓	✓
Suitable for Commercial Use?	✓	✓	✓	✓	✓	✓	✓
Pad Attached	○	✓	✓	✓	✓	✓	○
EIR Emboss?	○	○	✓	✓	✓	✓	✓
Painted Bevel?	○	○	✓	✓	✓	○	✓
Pressed Bevel?	○	○	○	○	○	✓	○
Extra Large Planks?	○	○	○	✓	✓	✓	○
Overall Thickness	2mm	5.5mm	5.5mm	6.5mm	8mm	8mm	12mm
Wear layer	12mil	20mil	20mil	20mil	28mil	20mil	AC3



Resistant to water & moisture, won't swell, peel or buckle when exposed.



Impeding microorganisms growth, long term protection against bacteria, fungi, and molds.



FloorScore certified for indoor air quality, free of phthalates, formaldehyde and VOC emissions.



Resistant to fire damage and won't assist the spread of fires.



Durable protection against indentation, stains, and scratches.



Production designed to a sustainable environment. ZERO trees used.



Glue Down Luxury Vinyl Plank

100% WATERPROOF LIFETIME

GD104 Blue Ridge

SPECIFICATIONS

INSTALLATION	PLANK SIZE	OVERALL THICKNESS	WEAR LAYER
Glue Down	7.25"x48"	2mm	12mil
PLANK/BOX	SQFT/BOX	BOXES/PALLET	SQFT/PALLET
24	58	60	3,480





GD101 Moccasin Creek



GD102 Stone Mountain



GD103 Cloudland Canyon



GD104 Blue Ridge



GD105 Indian Springs



GD106 Tallulah Gorge



SU



Rigid Core Luxury Vinyl Plank
100% WATERPROOF LIFETIME

SU309 Cherry Point

SPECIFICATIONS

INSTALLATION	PLANK SIZE	OVERALL THICKNESS	WEAR LAYER
Click	7.09"x48.03"	5.5mm	20mil
PLANK/BOX	SQFT/BOX	BOXES/PALLET	SQFT/PALLET
10	23.64	55	1300.20





SU301 Logging Camp



SU302 Parris Island



SU303 Cumberland



SU304 Catalina



SU305 Lake Lanier



SU306 Petrified Forest



SU307 Everstill Forest



SU308 Oceanside



SU309 Cherry Point



SU310 Kaneohe Bay



SU311 Northshire



SU312 River View

PR WOOD



Rigid Core Luxury Vinyl Plank

100% WATERPROOF LIFETIME

PR410 Paradise Bay

SPECIFICATIONS

INSTALLATION	PLANK SIZE	OVERALL THICKNESS	WEAR LAYER
Click	7.16"x48.03"	5.5mm	20mil
PLANK/BOX	SQFT/BOX	BOXES/PALLET	SQFT/PALLET
10	23.9	65	1553.5





PR401 North Haven



PR402 Saratoga



PR403 Sorrento



PR404 Beulah Valley



PR405 Dream Lake



PR406 Pikes Peak



PR407 Maroon Lake



PR408 Pleasant Hill



PR409 Rising Sun



PR410 Paradise Bay



PR411 Sunrise Meadow



PR412 Golden Meadow

PR STONE



Rigid Core Luxury Vinyl Plank

100% WATERPROOF LIFETIME

PR422 West Cliffe

SPECIFICATIONS

INSTALLATION	PLANK SIZE	OVERALL THICKNESS	WEAR LAYER
Click	12"x24"	5.5mm	20mil
PLANK/BOX	SQFT/BOX	BOXES/PALLET	SQFT/PALLET
12	24	66	1584





PR421 Rock River



PR422 West Cliffe



PR423 Gray Mountain



PR424 Glacier Gorge

PM



Rigid Core Luxury Vinyl Plank

100% WATERPROOF LIFETIME

PM501 Olympic

SPECIFICATIONS

INSTALLATION	PLANK SIZE	OVERALL THICKNESS	WEAR LAYER
Click	9.05"x60"	6.5mm	20mil
PLANK/BOX	SQFT/BOX	BOXES/PALLET	SQFT/PALLET
6	22.64	48	1086.72



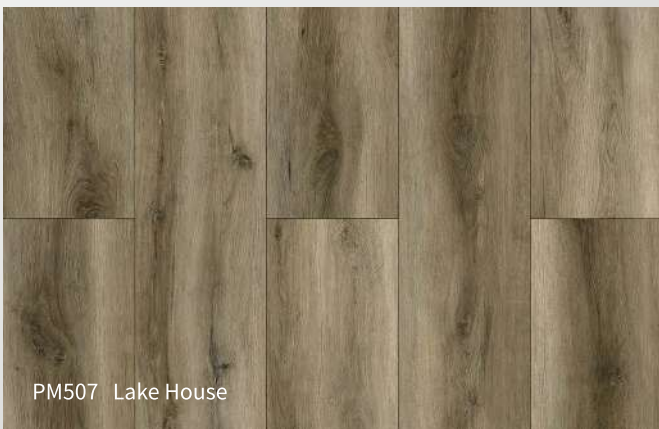
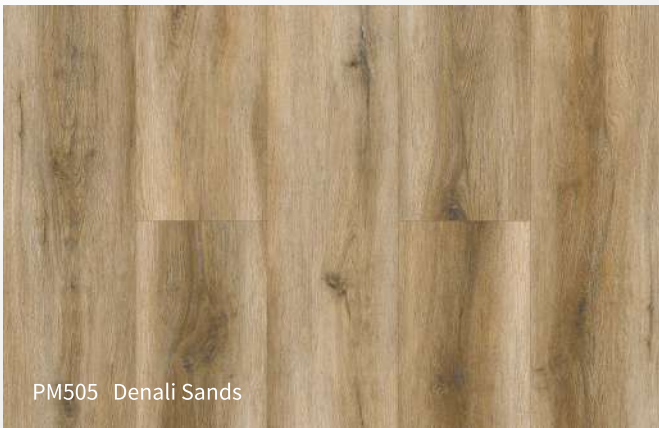

PA



PA804 Reina Oak

Rigid Core Luxury Vinyl Plank

100% WATERPROOF LIFETIME

SPECIFICATIONS

INSTALLATION	PLANK SIZE	OVERALL THICKNESS	WEAR LAYER
Click	9.06"x60"	8mm	28mil
PLANK/BOX	SQFT/BOX	BOXES/PALLET	SQFT/PALLET
5	18.87	52	981.24





PA801 Coastal Dunes



PA802 Royal Sands



PA803 Prestige Oak



PA804 Reina Oak



PA805 Winery Oak



PA806 Melrose



PA807 Chardonnay



PA808 Biltmore



PA809 Barrel Oak



100% Waterproof



Phthalate Free



Scratch-Shield



Stain-Shield



Bacteria-Shield



Pet Friendly

PU

WPC Engineered Vinyl Plank

100% WATERPROOF LIFETIME

PU601 Bonita Springs

SPECIFICATIONS

INSTALLATION	PLANK SIZE	OVERALL THICKNESS	WEAR LAYER
Click	7.09"x59.84"	8mm	20mil
PLANK/BOX	SQFT/BOX	BOXES/PALLET	SQFT/PALLET
8	23.56	65	1531.4





PU601 Bonita Springs



PU602 Gallatin Forest



PU603 Cherokee



PU604 Kobuk Valley



PU605 Smokey Mountain



PU606 Florence



PU607 Montana



PU608 Ventura

● **Pressed Bevels for Realistic Aesthetics**

A revolutionary technique that presses the edges of each plank uniformly to enhance realism, depth and dimension, presenting a more authentic wood-look and luxurious appearance.

● **Comfortable Underfoot**

The 8mm thickness and three-layer engineered composite structure provide a highly comfortable, cushioned feel underfoot, along with added sound insulation, which is often a desirable feature in high-end residential spaces.

● **Excellent Sound Absorption**

The thickness and composite structure of PU collection, along with added padding, provide effective sound insulation, reducing noise in multi-level buildings and busy areas.

● **Pet and Kid Friendly**

Certified by GreenGuardGold and FloorScore Indoor Air Quality (free of formaldehyde, phthalates, VOC and heavy metals), along with durability, scratch resistance, and waterproof features make it well-suited for households with pets and children, as it withstands spills, claws, and play.

PL

Water Resistant Laminate

WATER RESISTANT LIFETIME

PL701 White Cliffs

SPECIFICATIONS

INSTALLATION	PLANK SIZE	OVERALL THICKNESS	WEAR LAYER
Click	7.67"x47.83"	12mm	AC3
PLANK/BOX	SQFT/BOX	BOXES/PALLET	SQFT/PALLET
6	15.3	65	994.5



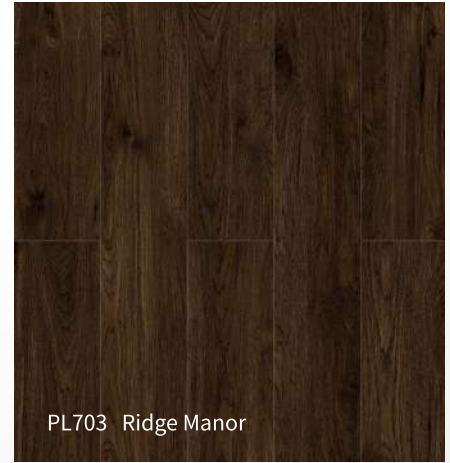

● **WATER RESISTANT**

Constructed with premium black spruce core technology, enhanced with denser, higher water-resistant performance up to 72 hrs with moisture and water spills.

● **SUPER SCRATCH FREE**

Proprietary superior scratch free technology provides you with the most desirable choice of water defense and surface guard flooring style.

● **LARGE INSTALLATIONS**

HomeLike strikes for a revolutionary fashion forward flooring solution enabling the collection 55% more dimensionally stable than standard laminate core, which allows you to install in rooms as large as 4,000 square feet without use of transition or expansion moldings, even through doorways.

● **EASY CARE**

Enlightened by it's high water resistance performance, you can super easily wet mop and clean the floor with all purposes cleaners!

● **FAMILY FRIENDLY**

Both CA-CARB Phase II certified and FloorScore Indoor Air Quality certified, protecting your family members to breathe freshly in everyday life.

CC

Rigid Core Luxury Vinyl Plank

100% WATERPROOF LIFETIME

CC001 Laurel Springs

SPECIFICATIONS

INSTALLATION	PLANK SIZE	OVERALL THICKNESS	WEAR LAYER
Click	7.17"x48.03"	5mm	12mil
PLANK/BOX	SQFT/BOX	BOXES/PALLET	SQFT/PALLET
12	28.68	55	1577



CREATED BY
SCS Global Services





CC001 Laurel Springs



CC002 Sandy Point



CC003 Harmony



CC004 Golden Coast



CC005 Hope Springs



CC006 Rosemary



CC007 Heritage



CC008 Redwood Falls



CC009 Clear Lake



CC010 Avalon



CC011 Regent



CC012 Timber Lake

AR



Rigid Core Luxury Vinyl Plank

100% WATERPROOF LIFETIME

AR134 Placid Cabin

SPECIFICATIONS

INSTALLATION	PLANK SIZE	OVERALL THICKNESS	WEAR LAYER
Click	7.09"x48.03"	5mm	20mil
PLANK/BOX	SQFT/BOX	BOXES/PALLET	SQFT/PALLET
10	23.64	55	1300.20





AR101 Nightfall Hills



AR103 Vintage Cabin



AR104 Natural Oak



AR105 Classic Lodge



AR106 Golden Pine

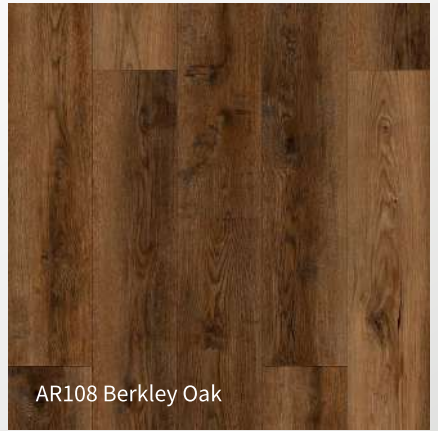

AR108 Berkley Oak



AR111 Sierra Sands



AR114 Rock Ferry



AR115 Fountain Hills



AR117 Vintage Hickory



AR118 Mill Creek



AR126 Sterling Oak



AR130 Lighthouse Bay



AR131 Brookfield



AR133 Canal Point



AR134 Placid cabin



AR135 Logging Camp Lite



AR136 Everstill Forest Lite



AR137 Cherry Point Lite



AR138 River View Lite



AR139 Kaneohe Bay Lite



AR140 Catalina Lite



AR141 Petrified Forest Lite



AR142 Lake Lanier Lite



AR143 Cumberland Lite



AR144 Northshire Lite



AR145 Parris Island Lite



AR146 Oceanside Lite



AR147 Sandy Plains



AR151 Redwood Forest



AR168 Mount Pleasant



AR169 Cambridge



AR170 Carolina Hickory



AR171 Monterrey

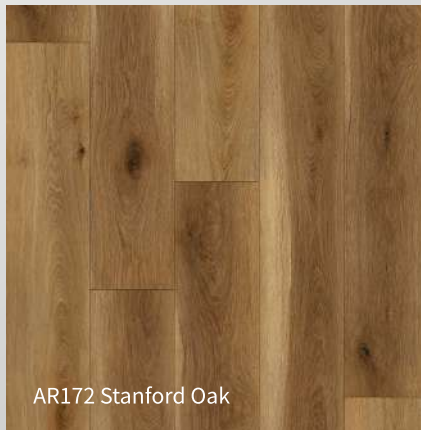

AR172 Stanford Oak



AR173 Ruby Falls

AA



Rigid Core Luxury Vinyl Plank

100% WATERPROOF LIFETIME

AA003 Mount Pleasant

SPECIFICATIONS

INSTALLATION	PLANK SIZE	OVERALL THICKNESS	WEAR LAYER
Click	9"x60"	6.5mm	22mil
PLANK/BOX	SQFT/BOX	BOXES/PALLET	SQFT/PALLET
6	22.44	52	1166.88





AA001 Lake Lanier



AA002 Kaneohe Bay

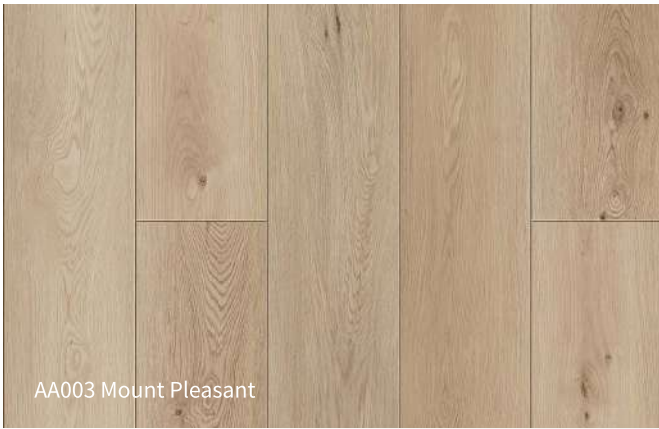

AA003 Mount Pleasant



AA004 Carolina Hickory

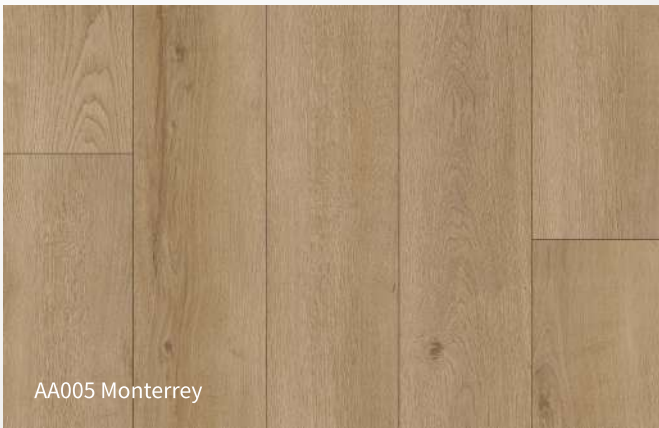

AA005 Monterrey



AA006 Brookfield



AA007 Placid Cabin

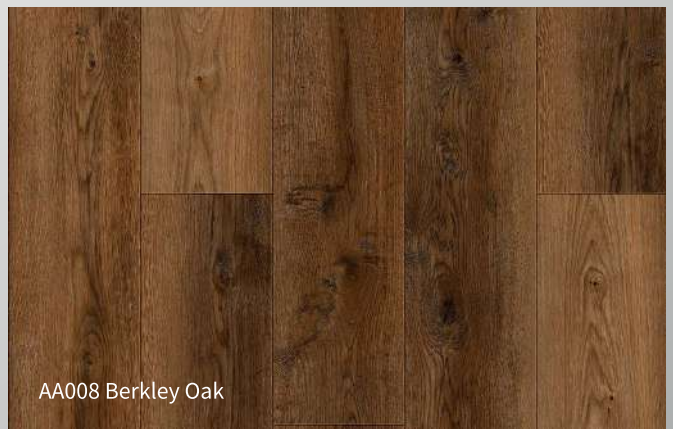

AA008 Berkley Oak

WG

WPC Engineered Vinyl Plank 100% WATERPROOF LIFETIME

WG007 Springbrook

SPECIFICATIONS

INSTALLATION	PLANK SIZE	OVERALL THICKNESS	WEAR LAYER
Click	8.98"x60"	8mm	20mil
PLANK/BOX	SQFT/BOX	BOXES/PALLET	SQFT/PALLET
8	29.92	44	1317





WG001 Ewa Beach



WG002 Belmont

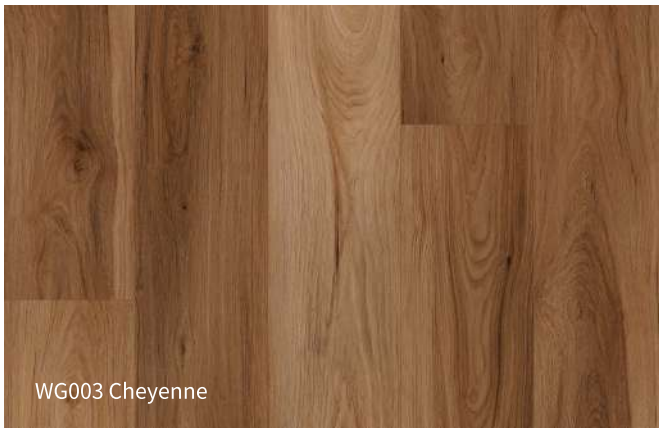

WG003 Cheyenne

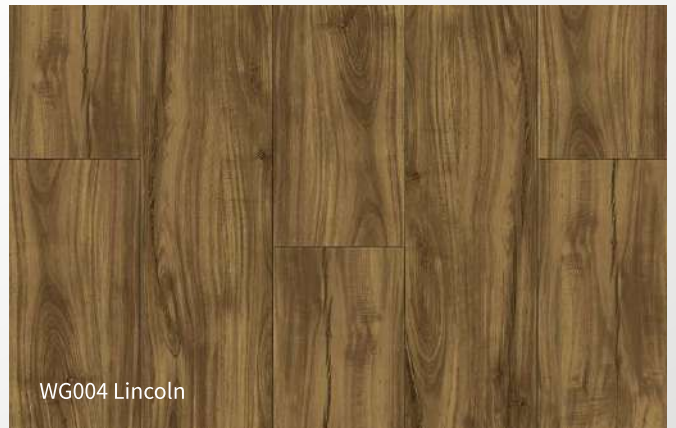

WG004 Lincoln

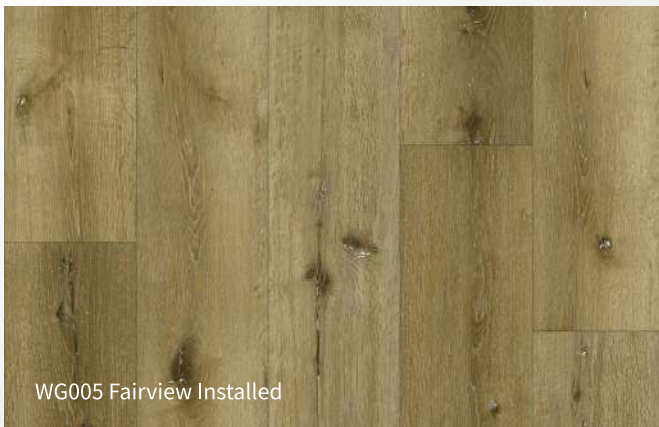

WG005 Fairview Installed

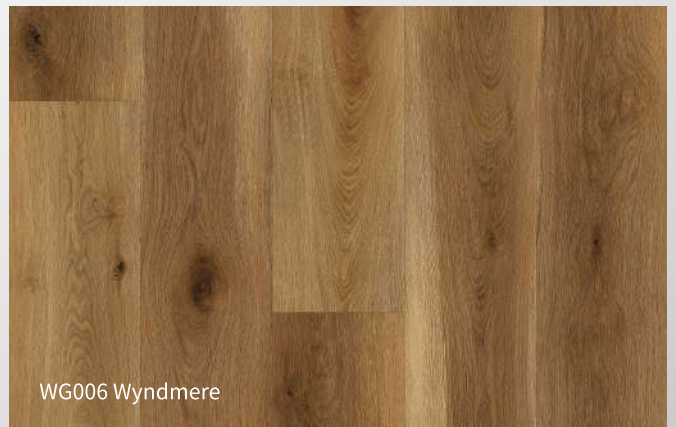

WG006 Wyndmere

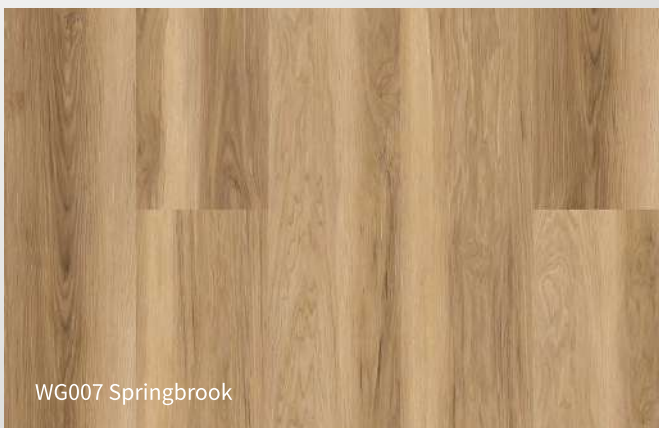

WG007 Springbrook

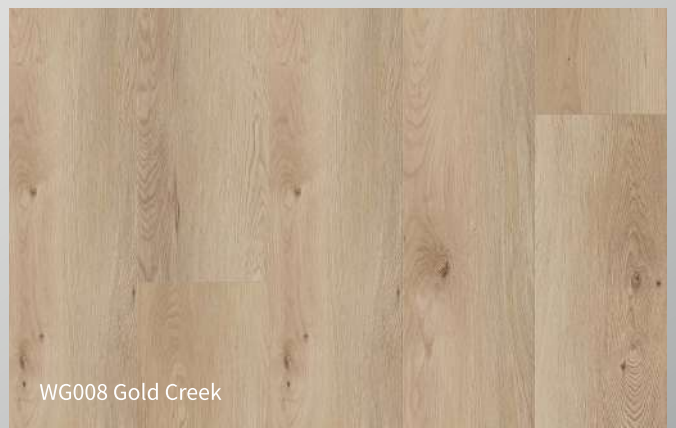

WG008 Gold Creek

T-molding

T-molding

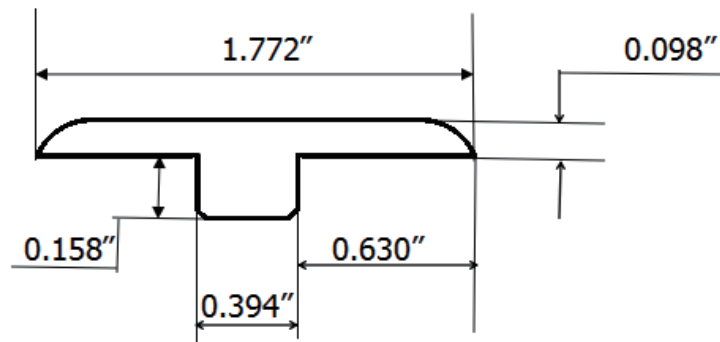

T-molding serves to cover the expansion gaps needed in a floating floor installation by bridging the space between two even surfaces. The low profile height and width bring a polished look to the job. They are highly wear resistant and 100% waterproof. The profile shown above is compatible with the AR line. Dimensions may vary to accommodate planks with different specifications.



Reducer

Reducer

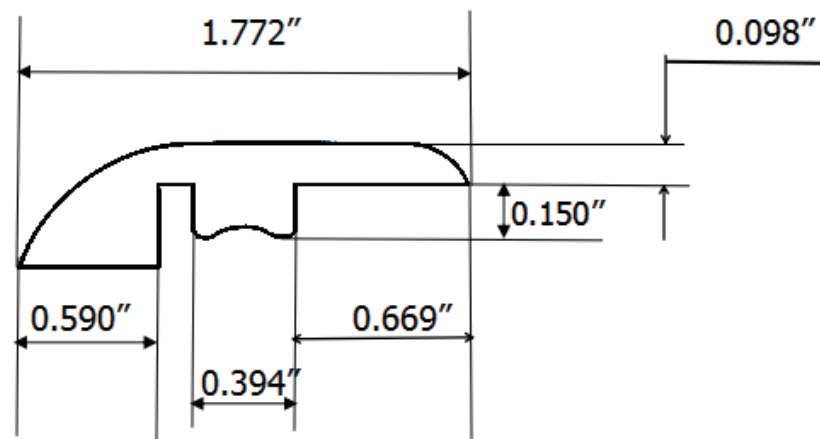

Reducer is the solution in locations where flooring of different heights meet together and a gentle slope is needed to bridge the two surfaces. 100% waterproof PVC construction. The profile shown above is compatible with the AR line. Dimensions may vary to accommodate planks with different specifications.



Stair Nose

Flush Stair Nose:

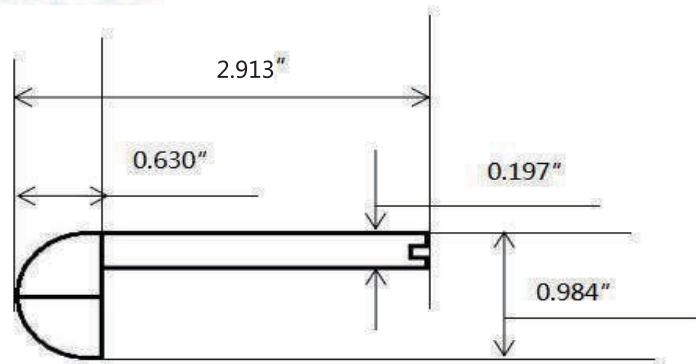

Stair Nose is 100% waterproof, can be installed as flush mounted. This versatile finished edge stair nose provides a solution for most staircase applications. The surface coating is made from reinforced polyurethane so the stairs continue to be eye catching for years to come. The profile shown above is compatible with the AR line. Dimensions may vary to accommodate planks with different specifications.



Full Step Stair Tread
Available for GV/SU/PM/PA/AR/AA/CC/SC,
and PR wood emboss



Full Step Stair Tread is an innovative, all-in-one integrated stair tread and nose, crafted from actual rigid vinyl planks. It features a straightforward, user-friendly installation, completing your stairs as a full step while providing a perfect match & natural look to the original flooring material.

Full Step Stair Tread is available now for GV/SU/PM/PA/AR/AA/CC/SC and PR wood emboss.

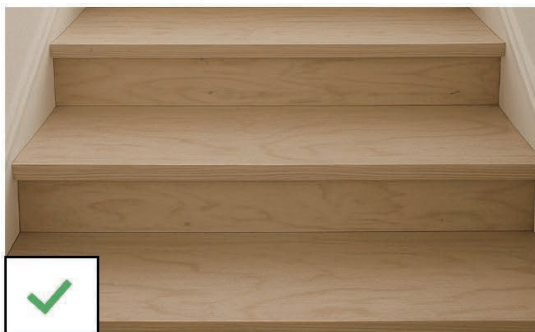

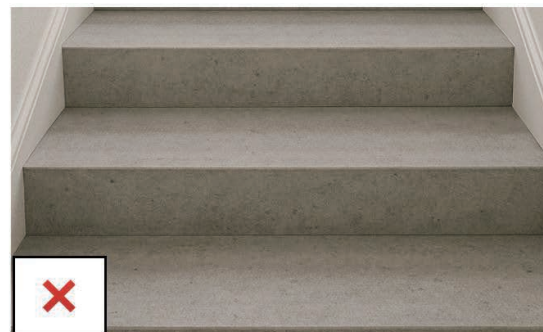

overhanging nosing

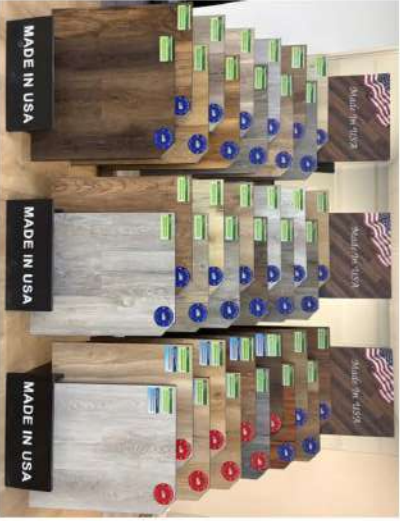

WITHOUT overhanging nosing

<p>Homelike#01</p>	<p>Homelike#02</p>	<p>Homelike Big #016</p>
		
<p>Display Dimensions</p>	<p>Display Dimensions</p>	<p>Display Dimensions</p>
<p>Board Size</p>	<p>Board Size</p>	<p>Board Size</p>
<p>Slot Qty</p>	<p>Slot Qty</p>	<p>Slot Qty</p>
<p>1214mm x 600mm x 2100mm Rack 48" x 24" x 83" Rack</p>	<p>970mm x 600mm x 2100mm Rack 38" x 24" x 83" Rack</p>	<p>1350mm x 635mm x 2060mm Rack 53" x 25" x 81" Rack</p>
<p>450*600mm</p>	<p>450*600mm</p>	<p>540*1500mm left side 16 slot 540*495mm right side 48 slot</p>
<p>30 slots</p>	<p>30 slots</p>	<p>64 slots</p>

<p>AR (5mm/20mil Rigid Core) Made-in-USA</p> <p>Incl. 3 racks, 36 display boards</p>  <p>Each Display W*D*H = 30" x 32" x 63" Each Display 12 slots</p>	<p>CC (5mm/12mil Rigid Core)</p> <p>Incl. 1 rack, 12 display boards</p>  <p>Each Display W*D*H = 30" x 32" x 43" Each Display 12 slots</p>	<p>WG (8mm/20mil WPC Engineered Vinyl)</p> <p>Incl. 1 rack, 8 display boards</p>  <p>Each Display W*D*H = 30" x 32" x 54" Each Display 8 slots</p>
---	---	--

Strap sets of all runningline collections are available, contact your sales rep/customer service to place an order!
For more information, please visit: www.homelikeflooring.com



HomeLike is a factory-owned brand with manufacturing operations in both the United States and overseas.

All HomeLike products are crafted in our self-owned facilities, ensuring comprehensive quality control, vertical operational efficiency, and a strong commitment to sustainability throughout the production processes.

Headquartered in Adairsville, Georgia, HomeLike's mission is to partner with local distributors and dealers to deliver premium vinyl and laminate flooring to American consumers at affordable prices.

By the end of 2024, HomeLike has established a robust network of over 500 active distribution partners, spanning the nation from Montana to Florida, from Maine to California.

These partners are supported by a highly dedicated local customer service team, built on the core values of Integrity and Dedication to create value for customers.



WHICH PRODUCT LINE IS RIGHT FOR YOU



HomeLike
Great Value



HomeLike
Select USA



HomeLike
Pro



HomeLike
Pro Max



HomeLike
Premium



HomeLike
Premium



HomeLike
Premium

Identification	Glue Down Luxury Vinyl	Rigid Core Made In USA	Rigid Core Pro	Rigid Core Pro Max	Rigid Core Signature	WPC Engineered Vinyl	Water Resistant Laminate
Installation	Glue Down	UNICLIC	UNICLIC	UNICLIC	UNICLIC	UNICLIC	UNICLIC
Waterproof?	✓	✓	✓	✓	✓	✓	○
ScratchGuard Finish?	✓	✓	✓	✓	SHIELD4MAX™	✓	✓
Suitable for Commercial Use ?	✓	✓	✓	✓	✓	✓	✓
Pad Attached	○	✓	✓	✓	✓	✓	○
EIR Emboss?	○	○	✓	✓	✓	✓	✓
Painted Bevel?	○	○	✓	✓	✓	○	✓
Pressed Bevel?	○	○	○	○	○	✓	○
Extra Large Planks?	○	○	○	✓	✓	✓	○
Overall Thickness	2mm	5.5mm	5.5mm	6.5mm	8mm	8mm	12mm
Wear layer	12mil	20mil	20mil	20mil	28mil	20mil	AC3



www.homelikeflooring.com

